



SJ series Relay Sockets (PC Board Terminal)

PC board socket for RJ plug-in terminal relay.

- Used for RJ series plug-in terminal relay.
- 1-pole: 12, 2-pole: 8A
- Latch makes it easy to install and removal the relay.

Applicable Standards	Mark	Certification Organization / File No.
UL508		UL recognized, UL File No. E62437
CSA C22.2 No. 14		CSA File No. LR84913
EN60999-1		EU Low Voltage Directive (Finger-safe screw terminal only)

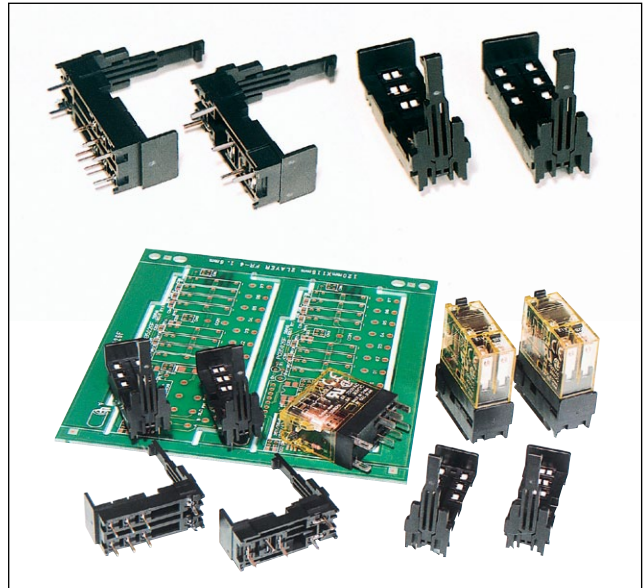

Sockets

No. of Poles	Part No.	Ordering No.	Package Quantity
1-pole	SJ1S-61	SJ1S-61PN10	10
	SJ1S-61	SJ1S-61PN50	50
2-pole	SJ2S-61	SJ2S-61PN10	10
	SJ2S-61	SJ2S-61PN50	50

Specifications

Model	SJ1S-61	SJ2S-61
Rated Current	12A	8A
Rated Insulation Voltage	250V AC/DC	
Insulation Resistance	100MΩ minimum (500V DC megger)	
Dielectric Strength	Between contact and coil:	5000V AC, 1 minute
	Between contacts of the same pole:	1000V AC, 1 minute
	Between contacts of the different pole:	3000V AC, 1 minute
Vibration Resistance	Damage limits: 90 m/s ²	
	Resonance: 10 to 55 Hz, amplitude 0.75 mm	
Shock Resistance	Damage limits: 1000 m/s ²	
Operating Temperature	-40 to +70°C (no freezing)	
Storage Temperature	-55 to +85°C (no freezing)	
Operating Humidity	5 to 85% RH (no condensation)	
Storage Humidity	5 to 85% RH (no condensation)	
Weight (approx.)	4.2g	4.5g

Dimensions

SJ1S-61

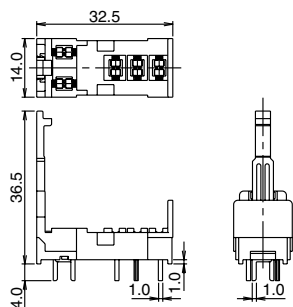

SJ2S-61

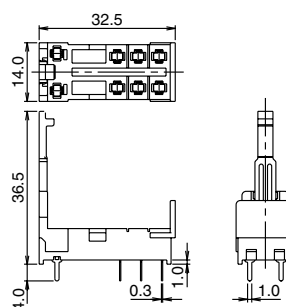

Mounting Hole Layout/Terminal Arrangement (bottom view)

SJ1S-61

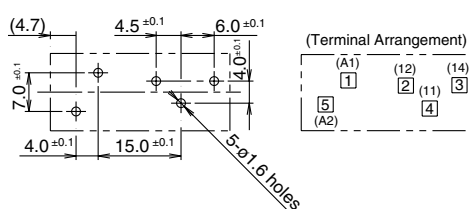

SJ2S-61

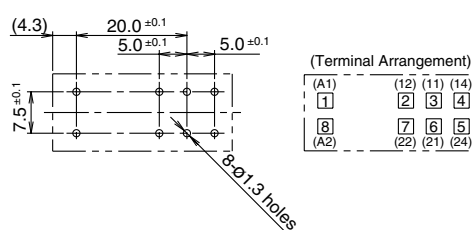

SJ series Relay Sockets (PC Board Terminal)

Operating Instructions

Installing the relay

Press in the relay to the socket by guiding the latch to pass through the slit.

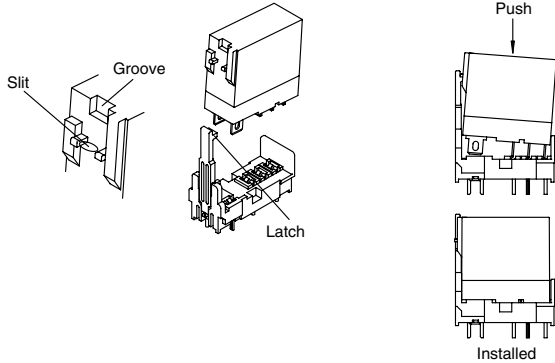

The relay is in place if the latch fits the groove completely. The latch swings open and can stop at the intermediate position.

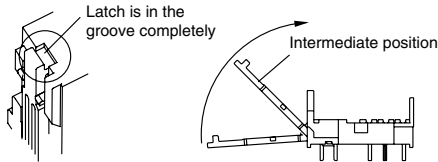

Removing the relay

Pull the latch, and pull out the relay from the socket.

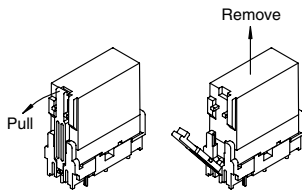

The relay can be removed by fingers or by using the removal tool (MT-101).

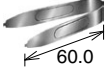
Description & Shape	Part No.
	MT-101

Soldering

Use a soldering iron of 60W (350°C), and quickly complete soldering with approximately 3 seconds. Do not use flow or dip soldering. Sn-Ag-Cu is recommended when using lead-free solder.

PC Board Pattern Design

Press in the relay to the socket by guiding the latch to pass through the slit.

On the bottom of SJ1S-61, metal parts other than the solder leads re exposed to the mounting side of PC board as shown in the following figure as marked with *. Take these metal parts into consideration when designing the PC board.

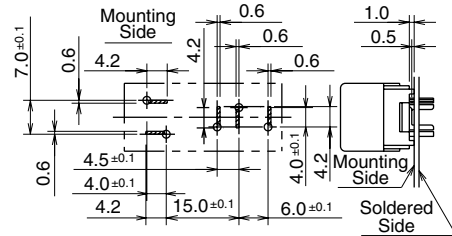

Switches & Pilot Lights

Flush Silhouette Switches

Emergency Stop Switches

Control Stations

Display Lights

Operator Interfaces

PLCs

Softwares

Relays

Sockets

Timers

Terminal Blocks

Circuit Protectors

Power Supplies

Sensors

Ex-proof Control Boxes

Barriers

LEDs

Safety Products

Information