

# MZ SERIES

## MINIATURE NON-RESET ELECTRIC COUNTER

- Non-Reset, Super mini size
- Low Cost, Low power consumption
- Suitable for limited space installations in office equipments, amusement equipments, etc.
- Applications : Slot Machine, Copy Machine, Fax Machine, Vending Machine, Other Industrial Machine

### ■ MODEL SELECTION

TYPE	MODELS	DIGITS	MOUNTING	CONNECTION	
NON-RESET TOTAL COUNTER	MZ - 600	6	Rear	LEADWIRE	
	MZ - 700	7			
	MZ - 620	6	Base		
	MZ - 720	7			
	MZ - 630	6	Behind Panel (Screw Mount)		
	MZ - 730	7			
	MZ - 640	6	Base		
	MZ - 740	7			
	MZ - 670	6	Panel (Snap-in-type)		
	MZ - 770	7			
	MZ - 602	6	PCB		TERMINAL PIN ( Pitch : 12.7 mm)
	MZ - 702	7			
	MZ - 612	6	PCB		TERMINAL PIN ( Pitch : 10 mm)
	MZ - 712	7			

### ■ SPECIFICATIONS

Display	6 digits : 3.0 x 2.0mm / 7 digits : 3.0 x 1.6 (white on black background)
Power Source	DC 12V, 24V
Voltage Fluctuation	-15 - +10%
Power Consumption	1.2 W
Continuous Energizing	Permissible
Counting Method	One pulse - One count (energizing - ½ count, unenergized - ½ count )
Counting Speed	20Hz
Pulse Width	50msec. minimum
Make (Duty)	1 : 1
Count Life	6 digits : 3,000,000 counts minimum / 7 digits : 10,000,000 counts minimum
Reset	None
Connection	Leadwire 265mm / PCB Type: Pin
Operating Temperature	-5°C - +40°C (non-freezing)
Operating Humidity	85%RH maximum (non-condensing)
Test Voltage	AC1,500V for 1 minute
Insulation Resistance	50MΩ minimum (500VDC megger)
Vibration	Endurance : 16.7 Hz, Width : 4mm ; XYZ each direction for 1 hour Malfunction : 10 - 55 Hz, Width : 0.5mm ; XYZ each direction for 10 mins.
Shock	Endurance : 294 m/s <sup>2</sup> (30G) XYZ 5 times each direction, Total : 30 times Malfunction : 49 m/s <sup>2</sup> (5G) XYZ 4 times each direction, Total : 24 times
Construction	Cover : Plastic (Black)
Weight	30 grams

# DIMENSIONS

**MZ - 600 • 700**

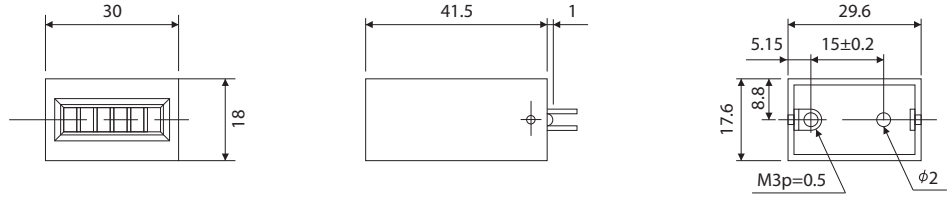

**MZ - 620 • 720**

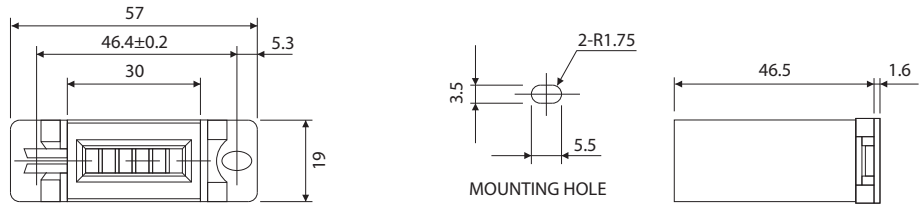

**MZ - 630 • 730**

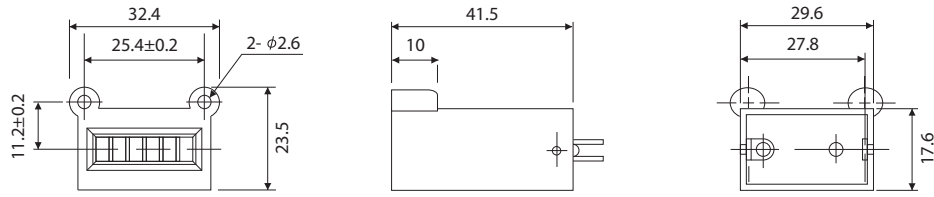

**MZ - 640 • 740**

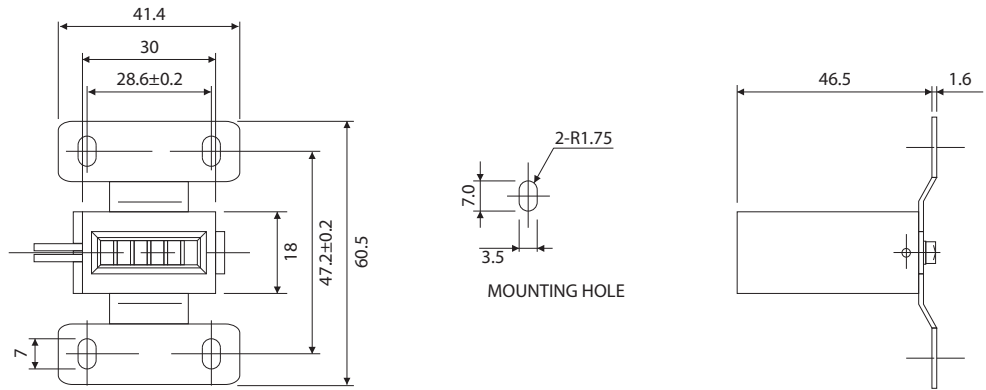
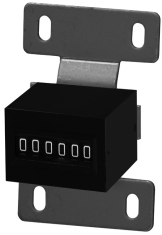

**MZ - 670 • 770**

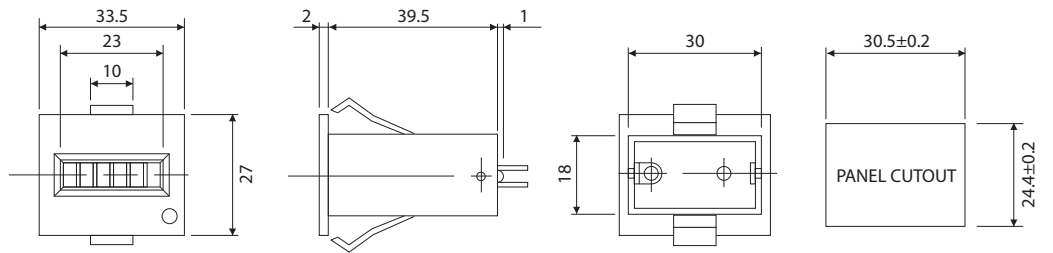

**MZ - 602 • 702**

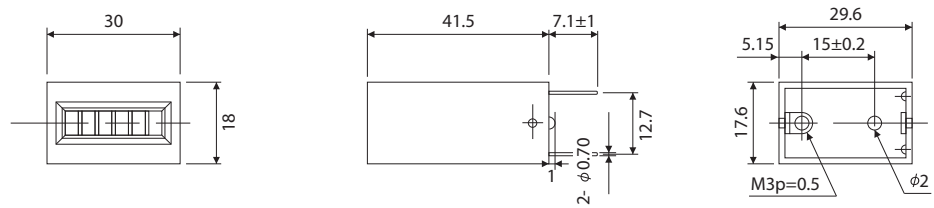

## DIMENSIONS

MZ - 612 • 712

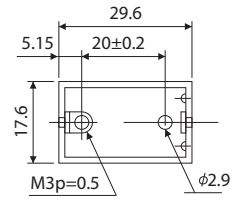
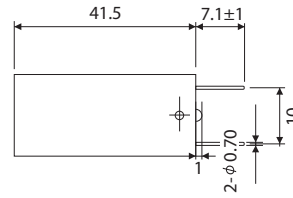
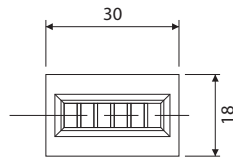

This catalog was last revised Sep. 21, 2021.

\*Subject to change without prior notice.

All Rights Reserved, Copyright © 2021, LINE SEIKI CO., LTD.



# LINE SEIKI CO., LTD.

37-7 Chuo-cho, 2-Chome  
Meguro-ku, Tokyo 152-0001 Japan  
Please visit our company website for contact details  
webtrade@line.co.jp  
<https://www.lineseiki.com>